

Development of a Predictive Functional Control Technique and Practical Applications to Chemical Processes

Sumitomo Chemical Co., Ltd.
Production & Safety Fundamental Technology Center
Satoru HASHIZUME

Practical methodology has been developed for the application of Predictive Functional Control (PFC) to certain processes which conventional Proportional-Integral-Derivative (PID) controllers have difficulty in handling. PFC is a variant of the widely-used Model Predictive Control (MPC) technology, and is characterized by its excellent control performance with a fairly simple calculation algorithm. PFC can be implemented using the standard functionalities of DCS (Distributed Control Systems) and PLC (Programmable Logic Controllers), which makes it easier than conventional MPC packages to implement and maintain in existing control systems.

In this paper, a general explanation of PFC as well as illustrative examples of its practical application will be described.

This paper is translated from R&D Report, "SUMITOMO KAGAKU", vol. 2015.

Introduction

Operation of chemical plants today has become increasingly complex and advanced to achieve competitive levels of safety, stability, product quality, minimum environmental impact, and adaptability to changes in market conditions.¹⁾ We have developed and employed computer-aided tools and techniques to realize "better" operation in our production facilities. Some instances of those tools and techniques are an operator training simulator²⁾, an alarm management system, dynamic process simulation and novel control technologies.

In this article, the focus is on predictive functional control (PFC) which is a simplified variant of Model Predictive Control (MPC). The most prominent characteristics of PFC are its algorithmic simplicity and ease of implementation compared to generally available MPC theories and products. In the following chapters, the historical background and a brief technical explanation of PFC will be given with examples of real-world applications in our plants.

Background for Introducing PFC

1. Historical Development of Process Control Industry and Technology

"Feedback control" is fundamental to automation in

the process industry, and Watt's steam engine system is said to be the first industrial device to employ this type of control method.³⁾ After the invention of feedback controllers, research was conducted independently in various industrial fields such as navigation of ships, operation of manufacturing processes such as for chemicals, and telecommunications. In the latter half of the 1940s, scattered results of these researches were collected together and systematized as Classical Control Theory. Proportional-integral-derivative (PID) control, which had been developed for automatic steering of ships, is an example of the technical elements which were incorporated into classical control theory.⁴⁾

PID control is a control technology with a feedback mechanism. The first controller based on a PID control algorithm was a pneumatic controller introduced by Taylor Instrument Company in 1936. PID controllers were well accepted because of their relatively simple theoretical background and ease of tuning (with the help of an intuitive tuning rule proposed by Nicholas and Ziegler⁴⁾), and gained widespread use in process industries for automating the control of flow rate, liquid level, pressure and temperature. Thereafter, with the introduction of new technologies such as electrical (digital) instruments and distributed control systems (DCS), there was a general shift towards remote monitoring and control in a central control room and away from tra-

ditional field operations. Today PID control still remains the most prevalent control technology used in process industries⁴, and especially in chemical plants, around 90% of the controllers are based on conventional PID algorithm. Even today, considerable research effort is still being devoted to optimal tuning methods and performance monitoring of PID controllers.⁵

While classical control technologies such as PID control were put into practical use and enjoyed practical success, Kalman, et al. established a novel control theory in the 1960s called “modern control theory”. One distinguishing feature of modern control theory is that it can deal with Multiple-Input-Multiple-Output (MIMO) systems, unlike classical control theory which basically can deal with Single-Input-Single-Output (SISO) systems. Amongst various techniques in modern control theory, Model Predictive Control (MPC), which was conceived in the late 1960s and intensively developed through the 1970s, had the most significant impact on the process control industry. Notable early commercial MPC packages include IDCOM (Identification and Command) by Richalet and DMC (Dynamic Matrix Control) by Cutler and Remaker. Thereafter, different kinds of MPC products with different features and improvements have been developed and marketed by a number of companies in process industries. For users to make use of MPC, they usually purchase one of the commercially available MPC packages and apply it to their own plants. According to a report by Que et al., the total number of MPC packages which have been applied in process industries such as refining, petrochemicals and chemicals was approximately 4600 by the end of 2003.⁶ Regarding the Japanese market, the result of a survey conducted in 2009 by the 143rd committee on process systems engineering of the Japan Society for the Promotion of Science shows that Japanese chemical companies principally use MPC packages as an “advanced control” solution.⁷ One reason why MPC has penetrated process industries is that commercially available MPC packages are generally equipped with functionalities which realize holistically stable operation of the plant as well as optimization in terms of critical variables such as production costs while considering various constraints.⁶

Meanwhile, Richalet developed another model-based control algorithm called Predictive Functional Control (PFC). Prominent features of PFC are the simplicity and customizability of its control algorithm depending on the nature of targeted processes. Quite a number of PFC

applications have been reported, especially in recent years, in a wide range of technical fields. Fields of PFC application include mechatronic servo systems⁹ which require very precise and fast control in the order of milliseconds, and highly nonlinear MIMO processes⁶ such as chemical plants. Since the control period of PFC can be as short as conventional PID controllers, PFC is sometimes simply used to replace an unsatisfactorily-performing PID controller to improve controllability.¹⁰

2. Overview of MPC applications in chemical plants

Fig. 1 shows an example of a control system with a hierarchical structure using MPC. In this control system, PID controllers implemented on DCS are used to control each process variable such as flow rate, pressure, liquid level and temperature. MPC, as the upper level controller, calculates and sends appropriate set-points for each PID controller to achieve stable operation of the whole plant. In addition, direct control is carried out for processes where simple PID controllers do not give satisfactory results, such as sluggish quality control and inherently unstable reaction temperature control. Furthermore, an optimizer function on the top of the hierarchy can be used to supervise MPC to calculate optimal set-points for lower-level controllers, which enables both stable and optimal operation of the whole plant.

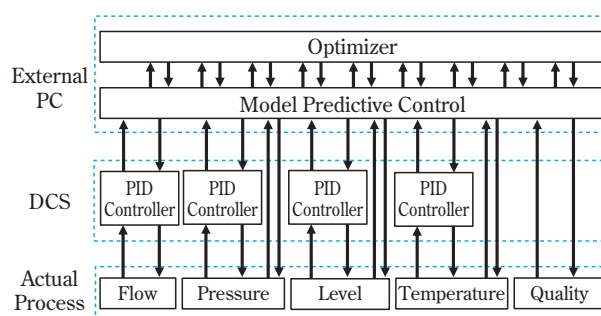

Fig. 1 General configuration of control systems employing MPC and PID controllers

3. Background of PFC introduction in our company

MPC can be employed to achieve holistic stabilization and optimization of the plant operation, but it is not always economically feasible because purchase, application and maintenance of commercial MPC packages often cost more than the benefits they would bring. Especially for relatively smaller plants, the absolute

amount of benefit from stabilization and optimization becomes inevitably smaller than that which would be expected for larger plants. Even though there is demand for MPC in slowly-responding systems such as quality control loops, since it is a financially discouraging option to introduce MPC packages, manual operations will remain. And for the multi-purpose batch processing plants, optimal control parameters inherently change from product to product and sometimes even from batch to batch, which makes it difficult to apply MPC and necessitates the control system design based primarily on conventional PID controllers with the help of sequential control or frequent manual interventions for critical parts such as reaction temperature control. In such plants, there has been a strong demand for novel control technology which can automate the operation of SISO control loops which are inherently quite difficult to be automated with simple PID controllers. New control technology which meets this criterion also needs to be based on a simple algorithm which can be implemented directly on DCS and does not need an external computer for its operation to reduce the cost of introduction. In our company, PFC caught attention because it has many advantages. PFC is an open technology with quite a simple algorithm, and it generally shows far better performance than PID controllers towards processes which show sluggish response. These features enabled PFC to be used freely, customized for different kinds of applications, and be implemented on pre-existing DCS in our plants. Study of PFC was started initially with the aim of using it in support of existing process control systems, which are mainly based on the mere combination of PID controllers, to facilitate automation of plant operations especially when the application of commercial MPC packages is not economically feasible (Fig. 2).

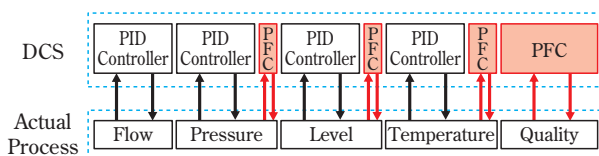

Fig. 2 Configuration of a control system employing PFC and PID controllers

Development of PFC Algorithms and Their Practical Applications

1. Basic concept of MPC^{6), 8)}

MPC is characterized by its use of a dynamic model

of the targeted system, which represents the response of the output to changes in the input (Fig. 3), for prediction of the output pattern in the future.¹¹⁾ Prediction results are then used for calculating the “optimal” input pattern so that the “desired” output pattern should be achieved. Here, being “desired” is in a sense that the predicted output pattern becomes as close as possible to the predefined “reference trajectory”, which is commonly an output trajectory calculated with a simple first order system and prescribes a smooth and stable approaching route to the set-points from the current position of the output (Fig. 4).

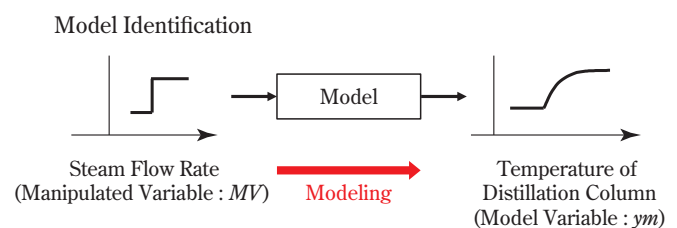

Fig. 3 Basic concept of model identification

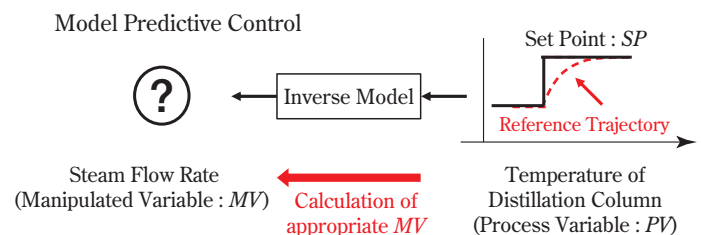

Fig. 4 Basic concept of model predictive control

PFC and general MPC can be distinguished by the difference in their calculation algorithms. In general MPC algorithms, a manipulated variable pattern for a specified period (control horizon M) starting at the present time step is determined such that the model variable (ym) pattern within another pre-specified period (prediction horizon P) and the reference trajectory become as close as possible. Various constraints, such as upper/lower bounds and limits on the magnitude of change for each step, are taken into consideration for the calculation of the future input pattern. As a result, calculation of a general MPC algorithm leads to large size constrained optimization problems which usually require a powerful external computer in addition to normal DCS to solve in real time to continuously control the targeted system (Fig. 5).

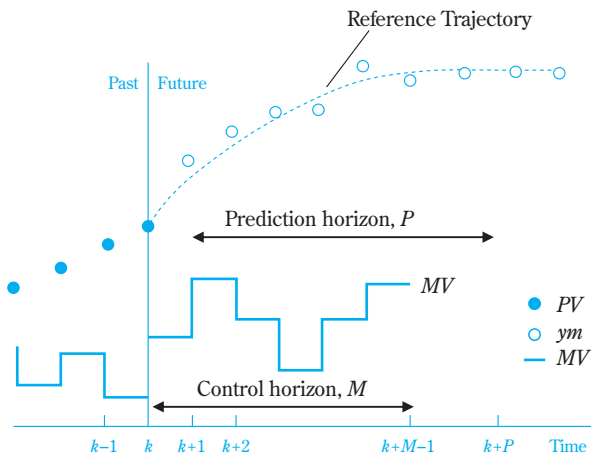

Fig. 5 General concept of MPC

On the other hand, PFC introduces a coincidence point (h) to replace the control horizon M and prediction horizon P , and a manipulated variable is determined once in every control period so that the model value and the reference trajectory match at the coincidence point (Fig. 6). The number of coincidence points and their intervals are left for determination by the user, and the manipulated variable can be obtained merely by solving a very simple algebraic equation when only one coincidence point is used.

PFC with only one coincidence point does not allow for long-term prediction, and is more similar to PID control than to general MPC algorithms in terms of controller stability, which should generally be regarded as a disadvantage. However, PFC still has many advantages over general MPC algorithms such as its simpler algorithm, general performance advantage over conventional PID controllers, and customizability depending on the nature of the targeted system.

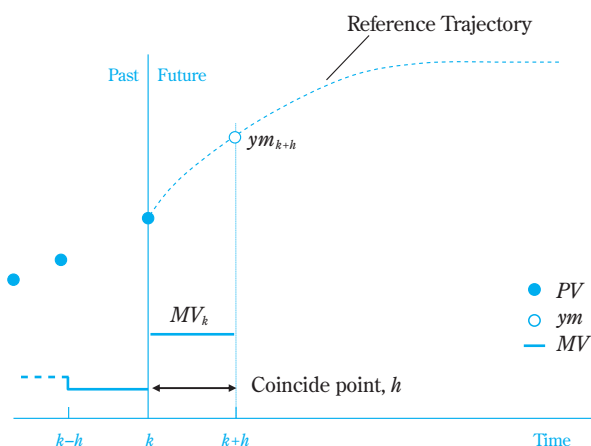

Fig. 6 Basic concept of PFC

2. PFC control algorithm⁸⁾

The dynamic model of a system can be expressed as the combination of simpler models such as first order, integrating and dead time element. Particularly in chemical plants, the majority of encountered processes can be well described by the “first order + dead time (FOPDT)” model (Fig. 7). PFC can handle different kinds of processes by varying its internal model, but in this article we will concentrate on explaining the applications in chemical plants in which an FOPDT model is used in the control algorithm.

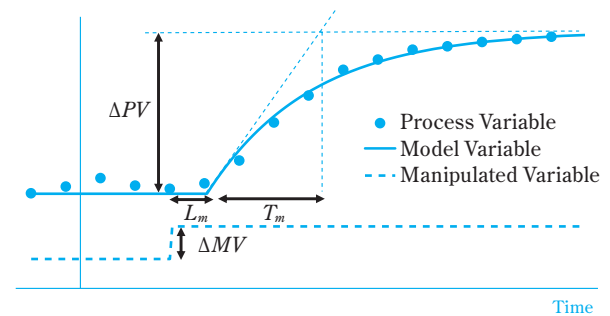

Fig. 7 Actual process response and its approximation by “1st order + dead time” process model

An FOPDT model is determined by three parameters: process gain K_m ($= \Delta PV / \Delta MV$), time constant T_m and dead time L_m . Let Δt be the time interval for one step in the discrete time expression. The recurrence formula for predicting the model value at the next time step ym_{k+1} from the present model value ym_k and manipulated variable MV_k can be expressed as in Equation (1). In Equation (1), the first term on the right hand side represents the effect of past controller actions, and the second term represents the effect of an action at the present.

$$ym_{k+1} = \alpha_m \cdot ym_k + K_m \cdot \beta_m \cdot MV_{k-L_m / \Delta t} \quad (1)$$

$$\alpha_m \equiv \exp\left(-\frac{\Delta t}{T_m}\right)$$

$$\beta_m \equiv 1 - \alpha_m$$

When there is no dead time ($L_m = 0$), Equation (1) will be derived.

$$ym_{k+1} = \alpha_m \cdot ym_k + K_m \cdot \beta_m \cdot MV_k \quad (1')$$

Simple first order types of reference trajectory, in which the present value of the process variable (PV_k) is

set to be the starting point, are commonly employed in PFC algorithms and they can be expressed as in Equation (2). $TRBF$ is an important parameter called “95% response time” and is used to adjust the response speed of PFC.

$$yr_{k+1} = [SP_k - PV_k] \cdot \left[1 - \exp\left(-\frac{3 \cdot \Delta t}{TRBF}\right) \right] \quad (2)$$

The manipulated variable is calculated so that the model value at the “coincidence point” (h -th step later than the present) and the reference trajectory will coincide. Here the reference trajectory is expressed as $\Delta yr_k = yr_{k+h} - yr_k = yr_{k+h}$, whose starting point is the present value of the process variable.

Likewise, the model behavior is expressed by a difference equation starting from the present time as $\Delta ym_k = ym_{k+h} - ym_k$. The manipulated variable that should be input at the present time step is calculated by Equation (3) which can be derived by letting $\Delta yr_k = \Delta ym_k$.

$$MV_k = \frac{[SP_k - PV_k] \cdot lh + \beta_m^h \cdot ym_k}{K_m \cdot \beta_m^h} \quad (3)$$

$$\beta_m^h \equiv 1 - \exp\left(-\frac{\Delta t}{T_m}\right)^h$$

$$lh \equiv 1 - \exp\left(-\frac{3 \cdot \Delta t}{TRBF}\right)^h$$

When the targeted process contains significant dead time, compensation for the dead time is necessary to prevent deterioration of control performance. As depicted in Fig. 7, dead time is the time taken by the targeted process to start reacting to a change in its input. Namely, the difference between the “present model value” and the “model value at $r_m (= L_m/\Delta t)$ steps before” matches the difference between the “present process value” and $PVpred$, which is the r_m -step ahead forecast of the process value (Fig. 8). Therefore, by employing $PVpred_k$ (PV_k corrected by the difference $ym_k - ym_{k-rm}$, which is the predicted change of process value after the

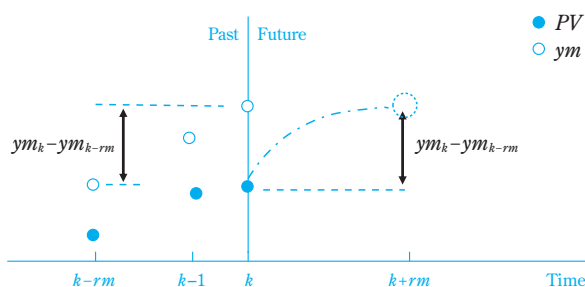

Fig. 8 Concept of dead time compensation

dead time) in place of PV_k , an equation for calculating the manipulated variable in consideration of dead time can be derived (Equation (4)).

$$MV_k = \frac{[SP_k - PVpred_k] \cdot lh + \beta_m^h \cdot ym_k}{K_m \cdot \beta_m^h} \quad (4)$$

$$PVpred_k = PV_k + (ym_k - ym_{k-rm})$$

Consequently the combination of equations (1') and (4) will be the fundamental PFC algorithm for the FOPDT process. Most of the parameters in the PFC algorithm are model parameters, and $TRBF$ will be the only parameter which users will need to adjust. If the $TRBF$ is shortened, the control action becomes faster, and vice versa. Besides, PFC implicitly contains the output feedback mechanism of MPC, which enables it to deal with disturbances, from the fact that its algorithm uses the error value (difference between the set-point SP_k and the process value PV_k at the present time) for the calculation of the manipulated variable.

3. Feedforward Compensation of Disturbances

As mentioned above, disturbances can usually be well handled solely by the feedback mechanism. For disturbances which are observable and can be modelled, controllability can be further improved by using a disturbance compensation function. The effect of an observable disturbance can be compensated for by taking into consideration the estimate of additional deviation of the process variable due to the disturbance Δydm_k after step h in the manipulated variable calculation (Equation (5)).

$$MV_k = \frac{[SP_k - PV_k] \cdot lh + \beta_m^h \cdot ym_k - \Delta ymd_k}{K_m \cdot \beta_m^h} \quad (5)$$

4. Comparison of PFC and PID control by simulation

The performance of a controller employing the PFC algorithm described above was studied by simulation. Fig. 9 shows the responses of PFC and PID controllers to a set-point step change for a process whose behavior is expressed by an FOPDT model with a process gain of 1.0[%/%], a process time constant of 300 sec, and a process dead time of 150 sec. In this simulation, $TRBF$ of PFC was set to 300 sec, and PID parameters used were obtained by internal model control (IMC) tuning rules with a value of $TRBF/3$ as the desired closed-loop time constant, and no modelling error was assumed for

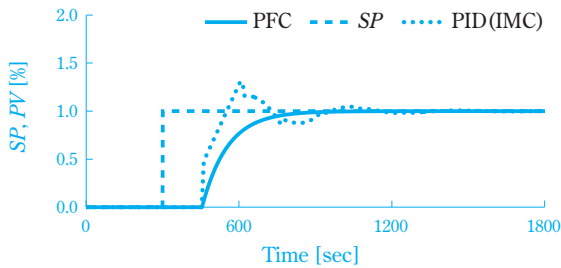

Fig. 9 Comparison of control performance by PFC and PID (tuned with IMC method)

this simulation. It is clearly confirmed in the result that PFC can settle around the new set point without overshooting at least as quickly as the PID controller.

From the above description and simulation result, the characteristics of the PFC algorithm can be summarized as follows.

- It is based on a simple control algorithm basically with two recurrence formulae.
- $TRBF$ is the only tuning parameter, thus the tuning of PFC is simpler compared to PID controllers.
- The control algorithm also includes dead time compensation.
- Incorporation of disturbance compensation is easy and straightforward.

Though it will not be rigorously described in this article, there is also an advantage that PFC can be extended to deal with MIMO processes, from which it can be said that PFC lies in the intermediate position between conventional PID control and typical MPC technologies. PFC is considered to be a promising candidate where the targeted process is difficult to control well by simple PID control and application of MPC is not economically feasible.

5. Implementation using standard DCS features¹²⁾

The basic calculation procedure for PFC can be expressed as a flow chart such as the one in Fig. 10. Model parameters such as α_m^h and β_m^h are pre-calculated in the step “(1) Initialize”. Current control mode (automatic or manual) is obtained in the step “(2) AUTO?” and if it is in the manual mode, bump-less calculation (a special type of calculation which is necessary to prevent sudden large changes in the manipulated variable when the control mode is changed from manual to automatic) is executed in the step “(3) Calculate bumpless”. If it is in automatic mode, model calculation is executed in accordance with Equation (1) in the step “(4) Calculate ym_k ”. When the current time step is at the coincidence

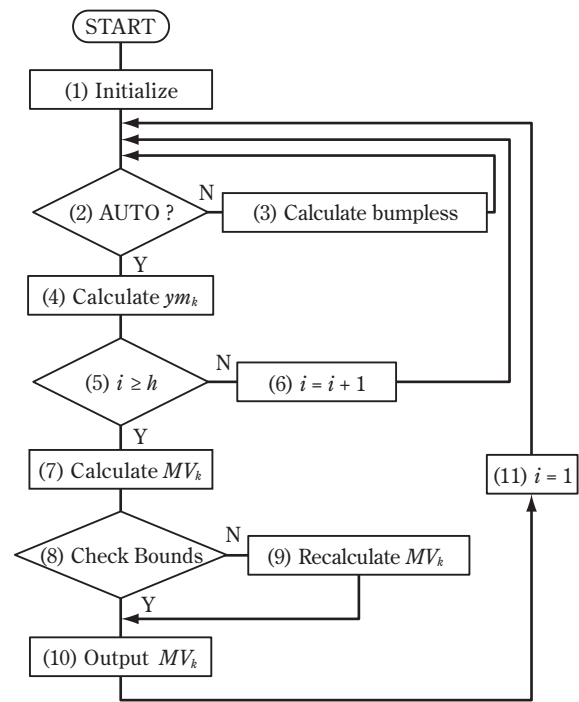

Fig. 10 Algorithm flowchart of PFC

point, the manipulated variable that should be input at that point is calculated in accordance with Equation (4) in the step “(7) Calculate MV_k ”. Control calculation between the steps (4) through (7) is repeated over and over again with a different period for each step to continuously control the targeted process.

Since Fig. 10 is in a flow chart format, it can be implemented easily by various programming languages for sequential control such as sequential functional chart (SFC) language and structured text (ST) language. As these kinds of languages for sequential control are commonly included in recent DCS packages, PFC can be implemented by using only the standard features of DCS because the PFC algorithm contains only simple recurrence equations and inequalities. In addition, if some parameters such as $TRBF$ must be adjustable by the user during normal operation, a specialized user interface similar to that of a PID controller faceplate can be developed.

Evaluation of Applications in Actual Plants

1. Application to distillation column temperature control¹²⁾

Following is an example of the application of PFC to distillation column temperature control which was conducted mainly for the purpose of validating the function and performance of PFC implemented on DCS.

The targeted process is a distillation column in which the bottom temperature is controlled by manipulating the reboiler steam rate. This control system consists of two control loops; the manipulated variable (*MV*) of the primary temperature controller will be the remote set-point (*SP*) of the secondary steam rate controller (Fig. 11). To obtain the process model used in the PFC calculation algorithm, a step-response test was carried out and the result was approximated by the FOPDT model (Fig. 12).

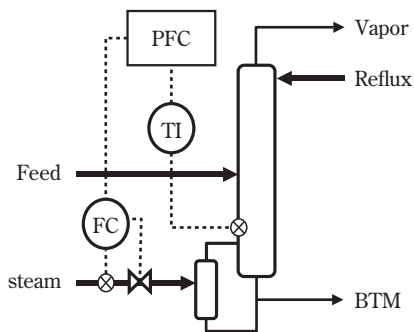

TI : Temperature Indicator
FC : Flow Rate to be controlled by PID controller

Fig. 11 Schematic diagram of a distillation column and its control structure

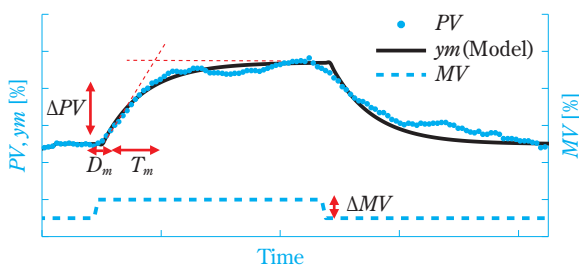

Fig. 12 Result of the step response test

PFC was designed based on the model parameters obtained, and the tracking performance and stability during the course of step set-point change was examined. As can be seen in Fig. 13, PFC behaved in a typical FOPDT behavior which is almost the same way as the theory predicts.

Including the one in Fig. 13, a total of 20 temperature controllers based on the PFC algorithm were developed and tested, and most of them showed satisfactory result that were not very different from theoretical predictions. These results convinced us that PFC implemented on DCS can generally perform as expected from theory.

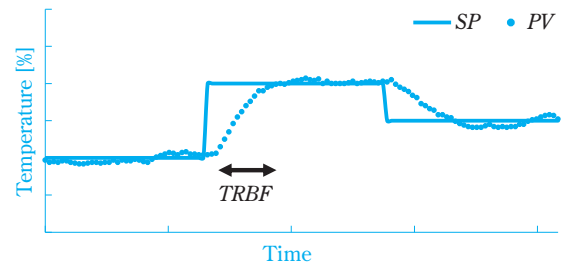
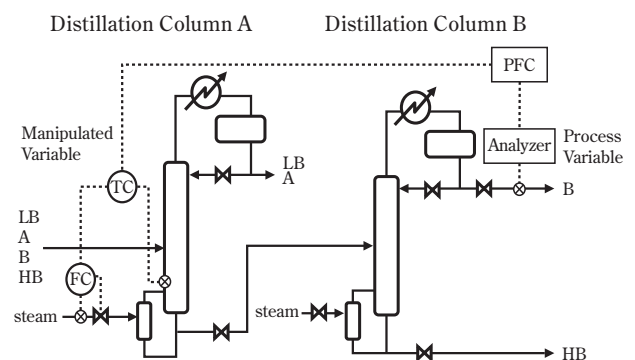

Fig. 13 Temperature of a distillation column controlled by PFC

2. Application to quality control¹³⁾

Composition (quality) control of large chemical processing equipment poses various difficulties which prevent it from being automated by a simple PID controller. Very long response time with significant dead time is often observed and analyzer results are usually only available intermittently.

Here is an example of distillation column product quality control which was successfully automated using PFC. The targeted process consists of two distillation columns in series (Fig. 14). Component A is to be recovered in the distillate of the first column, and component B is to be recovered in the distillate of the second column. Since there is an upper allowance of component A content in the distillate of the second column, the amount of A escaping into the bottom product of the first column is regulated by adjusting the set-point of the temperature controller (TC) of the first column. This system showed quite a long time constant and dead time (240 min and 70 min, respectively) which had made the



LB : Low Boiling point components
HB : High Boiling point components
A : component A
B : component B
FC : Flow rate to be controlled by PID controller
TC : Temperature to be controlled by PFC

Fig. 14 Product quality control scheme of distillation column train using PFC

process difficult to automatically control by a conventional PID controller and so it had been operated manually.

Since the introduction of PFC as the master controller of the first column TC, control of targeted product quality has been completely automated with a significantly reduced magnitude of fluctuation compared to the manual operation result (Fig. 15). This result demonstrates the effectiveness of PFC for the automatic control of distillation column product quality.

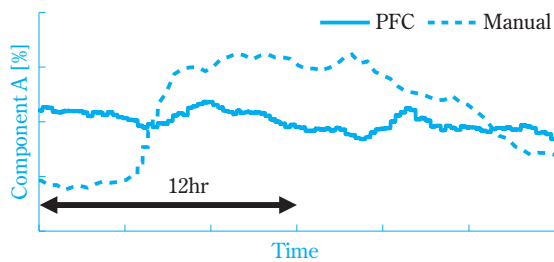

Fig. 15 Control of the product quality of a distillation column

3. Application to semi-batch reactor temperature control¹²⁾

Compared to continuous processes, it is generally considered more difficult to control batch or semi-batch processes because various conditions inherently and inevitably change with respect to time, and there are various disturbances such as reactions whose timing and magnitude are difficult to predict precisely. Employment of advanced control methods may be necessary in such cases because simple PID controllers often do not give satisfactory results.¹⁾

A facile method¹²⁾ for estimating reaction heat from a heat balance equation and integrating it with PFC has been proposed. Firstly in this method, model identification and the design of PFC are carried out without consideration of the reaction. Subsequently, a simplified heat balance equation is developed to estimate the reaction heat in real-time which can be used for the disturbance feedforward (FF) compensation to further suppress the temperature deviation caused by sudden generation of heat.

Following is an example of the application of a “real-time” disturbance inference technique on a semi-batch reactor schematically depicted in Fig. 16. The basic design philosophy for this system is that the reactor temperature Tr is controlled by adjusting the jacket inlet temperature Ti . In addition to the basic PFC algorithm,

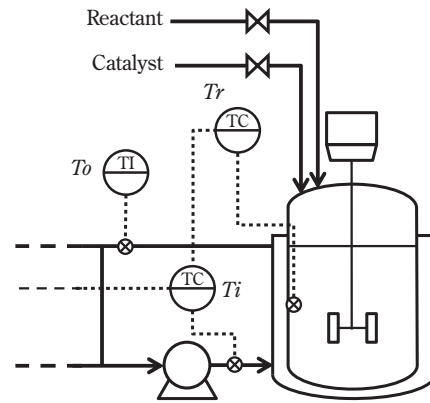

Fig. 16 Schematic diagram of a batch reactor and its control structure

feedforward functionality was used to deal better with the reaction heat.

For the sake of simplicity, the reaction heat Qr is estimated by the heat balance equation (6), which is based upon an assumption that the reaction mixture is uniformly mixed and the heat transferred from the coolant through the jacket will be used exclusively for either cancelling the reaction heat or changing the reactor temperature.

$$Qr_k = C_p \rho_m V \frac{Tr_k - Tr_{k-1}}{\Delta t} - UA(\bar{T}_{j_k} - Tr_k) \quad (6)$$

$$\bar{T}_{j_k} \equiv (Ti_k + To_k) / 2$$

If the specific heat capacity Cp , density ρ , reaction liquid volume V , heat transfer area A , overall heat transfer coefficient U and other various physical properties of this system are known, the instantaneous rate of heat generation by the reaction Qr_k can be estimated using the jacket inlet temperature Ti_k , jacket outlet temperature To_k and reaction temperature Tr_k at time k . Real-time reaction heat compensation, which significantly contributes in suppressing the temperature deviation, can be implemented using the feedforward functionality in the PFC algorithm. Possible adverse effects on controller performance which may arise from model error or measurement noise can be mitigated by smoothing the estimated disturbance signal using functions such as a first-order filter.

Fig. 17 shows the results of semi-batch reactor temperature control. In this system, some of the raw materials are initially fed into the vessel and the temperature is adjusted to and held constant at the predetermined level, and then the catalyst is fed gradually while maintaining the temperature within the allowable range. Operation by manual adjustment of the temperature

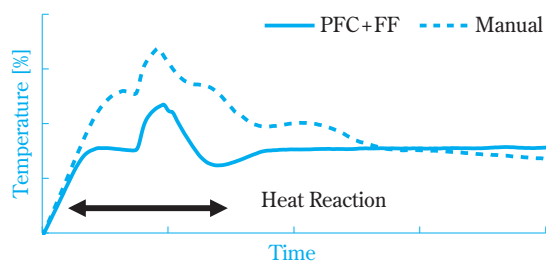

Fig. 17 Comparison of temperature control results by PFC+FF and manual operation

resulted in large deviation of temperature from the set-point during the course of the reaction, while the results using PFC with real-time reaction heat inference algorithm shows much less deviation.

This “in-situ compensation” method is useful particularly for processes in which it is difficult to predict the exact timing of disturbances, such as polymerization and crystallization that sometimes show inconsistently-patterned heat generation.

Conclusion

In this article, a basic theoretical background of PFC has been given with examples of practical application in Sumitomo Chemical plants. PFC differs from typical MPC in that it is far more facile than general MPC and can be implemented directly into DCS. PFC is increasingly attracting attention as a promising technology which contributes to the safe and stable operation of chemical plants by filling the gap between the conventional PID control and commercial MPC packages. Development and tests are still continuing in our company to establish PFC as a versatile and easy-to-use process control technology.

References

- 1) D.E. Seborg, T.F. Edgar and D.A. Mellichamp, “Process Dynamic and Control Second Edition”, WILEY (2003).
- 2) Y.Hiraishi and S.Hashizume, *Aromatics*, **64** (summer), 166 (2012).
- 3) E.Shimemura, “Jidou-Seigyō to ha Nani ka [What is the automatic control?]”, Corona (1999), P.22.
- 4) Y.Wakasa, “Survey Reports on the Systemization of Technologies; No.11, A Technical Survey of Process Control”, National Museum of Nature and Science (2008).
- 5) H. Kugemoto, *SUMITOMO KAGAKU*, **2010-II**, 32 (2010).
- 6) S.J. Qin and T.A. Badgwell, *Control Engineering Practice*, **11**, 733 (2003).
- 7) M.Kano, “Koudo-Purosesu-Seigyō ni Kansuru Anke-to Chyousa-Kekka-Houkokusyo [Survey Reports on the Advanced Process Control]”, the 143rd committee on process systems engineering of the Japan Society for the Promotion of Science (2009).
- 8) J. Richalet and D. O’Donovan, “Predictive Functional Control”, Springer (2009).
- 9) T.Satoh, K.Kaneko and N.Saito, *Journal of the Society of Instrument Control Engineers on Industrial Application*, **10** (15), 132 (2011).
- 10) Y.Noguchi, M.Kobashi and Y.Hashimoto, *Institute of Systems, Control and Information Engineers*, **52** (8), 285 (2008).
- 11) K.Kurotani, *Journal of the Institute Electrical Engineers of Japan*, **117** (10), 691 (1997).
- 12) S.Hashizume, K.Iwao and Y.Hiraishi, 58th Annual conference of The Institute of Systems, Control and Information Engineers, 313-5 (2014).
- 13) S.Hashizume and H.Kugemoto, *Aromatics*, **67** (spring), 117 (2015).

PROFILE



Satoru HASHIZUME
Sumitomo Chemical Co., Ltd.
Production & Safety Fundamental Technology Center
Researcher