

# Process Development and Application of Membrane Technology

Sumitomo Chemical Co., Ltd.  
Process and Production Technology Center  
Masahiko KURUMATANI  
Takenori KITaura

Membrane separation is the separation from a mixture, of components of different molecular weights or different chemical properties utilizing the separation ability of membranes. It is a far less energy intensive process than distillation because it doesn't involve any phase changes. Furthermore, the application of membrane technology is not limited to just separation ; emulsifications and reactions are also possible. The authors of this paper are currently working to develop processes based on such technologies and here they introduce some new technologies and report on their progress in applying these technologies to the separation of resin solutions, effluent treatment and the advanced purification of pigments.

This paper is translated from R&D Report, "SUMITOMO KAGAKU", vol. 2007-I.

## Introduction

With an awareness of molecular fractionation functional separation membranes and membranes with stronger chemical resistance have been put on the market in recent years, and the range of applications for membrane separation in industrial processes and environmental processing has been expanding. In addition, these are energy-saving processes that are not accompanied by changes in phase (no heating), and they are suitable for chemical compounds with poor thermal stability.

Classifying the various membrane separation techniques according to the propulsive force required for transmission, we can roughly divide them into microfilters that use pressure differences, ultrafiltration, nano filtration, reverse osmosis, pervaporation, grouped filter membrane separation and electro dialysis that makes use of differences in electric potential. Pressure driven membrane processes normally have the concentration for the substance being separated in a continuous phase set at 20% by weight. In addition, applications for a wide range of molecular weight distributions (molecular weights of around 10 - 100,000, **Fig. 1**) are possible through the selection of a membrane having a suitable molecular weight for fractionation (pore diameter, pore diameter distribution). On the other hand, electro dialysis is a separation method that makes use of ion exchange membranes and an electric field.

Ion exchange membranes are porous membranes that have a charge, and they have the property of only allowing cations or anions to pass through (called cation exchange membranes and anion exchange membranes). Elimination of the ionic components of water and concentration are carried out by combining this with electro dialysis. The drive force for separation is the difference electric potential, and the amount of ions transferred is proportional to the amount of electricity flowing. Electro dialysis has a higher rate of elimination and a greater concentration factor than the pressure driven membrane separation of reverse osmosis and the like.

In the following, we will describe the development of filter membrane separation and electro dialysis processes and applications development carried out by the authors.

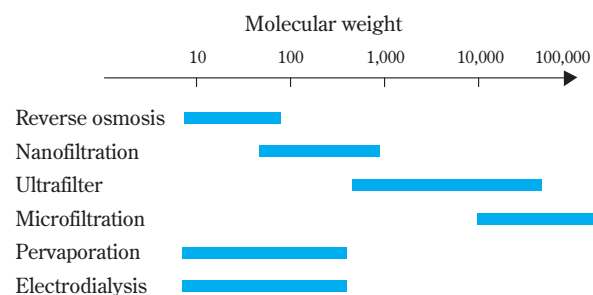

**Fig. 1** Applicable ranges of separation membranes [Data from reference 1 ]

## Membrane Separation Technology

### 1. Filter Membrane Separation

#### (1) Principles

This is a method for separation using the difference in the size of the small holes in the membrane and the size of the molecules, letting the propulsive force be a difference in pressure. A division can be made according to the diameter of the small holes in the membrane into reverse osmosis membranes (RO membranes), nano filter membranes (NF), ultra filter membranes (UF membranes) and microfilter membranes (MF membranes) (Fig. 1), and the molecular weights of the molecules that are the target of separation and the separation models differ for each of these.

#### (2) Filtering Method

For the filtering method, there is the cross flow filtration system where a fluid being processed flows parallel to the surface of the membrane, and the dead end filtration system where the fluid being processed passes through perpendicular to the surface of the membrane (Fig. 2). A flat membrane is used in dead end filtration, and an element where the membrane surface is parallel to the direction of flow is used in a cross flow filtration. Cross flow filtering is superior in the point that the formation of the gel layer on the membrane surface is controlled because of the shearing force caused by the flow of the fluid being processed, and it can be used in both continuous systems and batch processing.

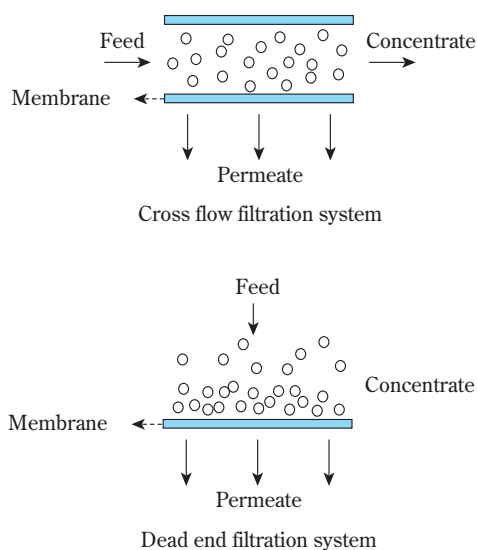

Fig. 2 Membrane separation system schemes

#### (3) Applications<sup>2)</sup>

Typically, there are three classes of fractionation applications for making products where the target substance is prevented from passing through or is passed through (or both) using purification applications for forming products or conversely concentration applications for forming products, or the selective permeability of the membrane.

#### (4) Evaluation of Performance

Evaluations performance in filter membrane separation are carried out by two indicators, the rate of rejection  $R$  (Eq. 1) of the substance being separated, and the permeation flux  $F$  (Eq. 2) of the fluid passing through. The rate of rejection is defined by the concentration  $C_b$  of the target substance on the supply fluid side and the concentration  $C_p$  target substance on the side where the fluid has passed through. Normally, the molecular weight of a target substance with a rate of rejection of 90% is used for the fractionated molecular weight.

$$R = 1 - \frac{C_p}{C_b} \quad (\text{Eq. 1})$$

The permeation flux is the amount  $W_p$  of the solution penetrating per unit surface area  $A$  during a unit time  $t$ , and the processing capacity of the membrane can be evaluated.

$$F = \frac{W_p}{t \cdot A} \quad (\text{Eq. 2})$$

### 2. Electrodialysis

In electrodialysis, there is an arrangement of multiple pairs of cation exchange membranes and anion exchange membranes, and concentration or elimination of the ionic substances or separation of the ionic substances and nonionic substances is carried out by applying an electric field to both ends. Normally, sulfonic acid groups<sup>3)</sup> that have a negative charge bond to ion exchange membranes. Therefore, only cations enter the cation exchange membranes. If an electric field is applied to both sides of the membrane, the cations inside the membrane move to the side of the negative pole along with the hydrated water molecules, and the cations pass through selectively. Since anion exchange membranes have a fixed positive charge like quaternary ammonium ions and allow anions to pass through selectively, they can concentrate salts or elimi-

nate salts through the use of combinations with cation exchange membranes as shown in Fig. 3.

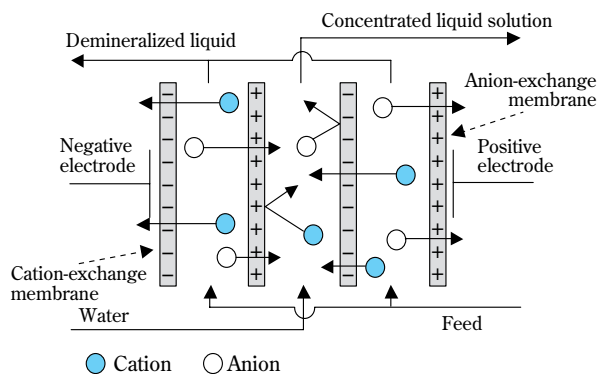

**Fig. 3** The principle of electrodedialysis membranes

### Development of Processes for Membrane Technology

#### 1. Filter Membrane Separation

After an initial survey of the properties (concentration, pH, presence or absence of SS components) of the fluid to be separated, a suitable membrane is selected based on the molecular weight of the substance being separated, the engineering data necessary for the process design that follows acquired, and the separation process designed based on that.

##### (1) Membrane Selection (Dead-End Filter Tests)

The important points for selection of membranes are rejection of the substance being separated permeation flux necessary for the design. Filter tests were carried out on a dead end parallel membrane tester, but before the tests were carried out, it was narrowed down to several candidate membranes based on the molecular weight of the substance being separated. The membrane performance of various types of membranes (RO membranes, NF membranes, UF membranes and MF membranes) on the market have been published using the rate of rejection for NaCl and the fractionated molecular weight, but since we do not know the rejection rate for substances being separated which would be a reference value for comparing the size of the diameter of the small holes in the membrane for them, it is difficult to narrow down the membranes with this alone. Therefore, the authors have created a separation performance map (Fig. 4) that shows the rejection rate of membranes for a model substance (several molecular weights). Using this, it is possible to narrow down the

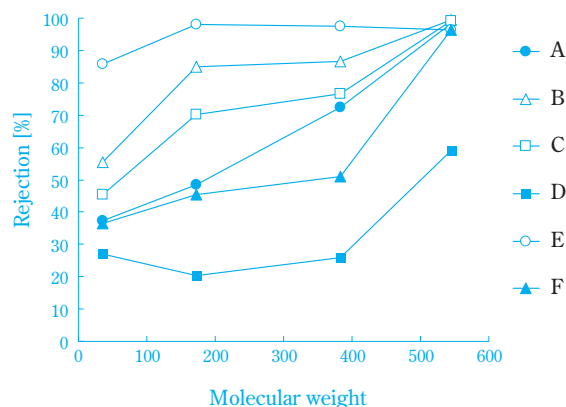

**Fig. 4** Relationship between molecular weight and rejection

candidate membranes using the separation map to a molecular weight of approximately 10,000 for the substance being separated.

Next, promising candidate membranes are selected by using the candidate membranes to measure the rejection rate and the permeation flux for the substance being separated using a dead end filtering test (0.1 - 3MPa).

##### (2) Acquisition of Engineering Data<sup>4)</sup> (Cross Flow Test Filter Tests)

Using the membranes selected in the dead end filtering tests, the engineering data necessary for process design (membrane surface area, membrane element arrangement (Fig. 5)) is acquired along with looking into whether across flow filter could be made practical. In the tests, it is important that an element similar to the type for actual equipment is used and that the measurements are under conditions (operating pressure, concentration and flow rate) as close as possible to actual equipment. The engineering data required varies according to the process, but the important data is shown below.

- Relationship between operating pressure and permeation flux
- Relationship between the supply flow rate for the element and the permeation flux

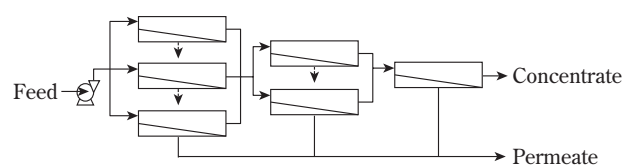

**Fig. 5** An example of an element sequence (Christmas tree sequence)

– Relationship between the concentration of the substance being separated in the supply fluid and the permeation flux

### (3) Membrane Process Design

#### 1) Selection of Membrane Processing System

There are continuous systems (with or without recycling), batch systems and diafiltration systems (Fig. 6), and a suitable system is selected according to the process characteristics (amount of fluid supplied, availability factor, surface area installed and economy). Typically, continuous systems are selected when the amount being processed is large, and batch systems are selected when the amount being processed is small.

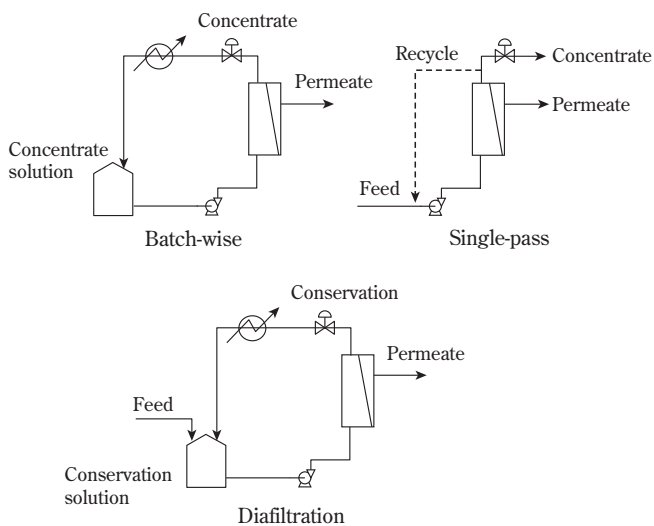

**Fig. 6** Filtration system

#### 2) Required Membrane Surface Area Calculations and Design of Membrane Element Arrangement

The relational equation for the concentration of the substance being separated in the supply fluid and the permeation flux at the operating pressure is used in the calculation of the required membrane surface area.

The surface area required varies a little according to way the arrangement of the membrane elements is constructed (number in parallel, number in series). If the number in parallel is large, the permeation flux can be increased and the membrane surface area is smaller, but the required capacity (flow rate) for the pump increases. On the other hand, if the number in series is large, we get by with a smaller requirement for the pump capacity, but the required surface area and the pressure loss increase.

Next is the construction of the membrane element arrangement, but the elements are determined by the maximum fluid supply for protecting the membrane (prevention of rupture and excessive concentration) and the minimum amount of concentration for the fluid. Therefore, each element is arranged (tree structure) to obtain that value.

## 2. Electrodialysis

The procedure for electrodialysis process development is selection of the membrane, acquiring the engineering data and basic process design as it was with filter membranes.

#### (1) Membrane Selection

The important points for selection of membranes are the permeation flux [ $\text{kg}/(\text{m}^2 \cdot \text{hr})$ ] having a sufficient value for the design per unit cell for the ions that are being separated (not letting the required membrane surface area become too large) and making the loss to penetrating fluids other than the substance targeted small (high rejection rate). The authors brought together a separation performance map where the performance of various ion exchange membranes has been evaluated by the permeation flux for various model substances (monovalent ions). As an example of this, the permeation flux data for p-toluenesulfonic acid (molecular weight of approximately 172) for various anions exchange membranes is shown in Fig. 7.

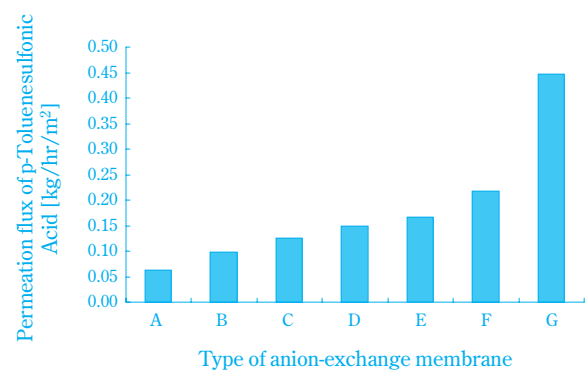

**Fig. 7** Rate of desalination of anion-exchange membrane

#### (2) Acquisition of Engineering Data

The engineering data (see below) required for process design is acquired along with making an assessment of whether it is practical in a small electrodialysis device (ASTOM Corp. Acilyzer 3S).

- Relationship between applied voltage and permeation flux
- Relationship between the concentration of the supply fluid and the permeation flux
- Grasping critical current density

### (3) Membrane Process Design

For operating systems, there are continuous systems, recycling continuous systems and batch systems, and they are divided for use according to the demineralization rate and amount of processing for implementation. Typically, when the amount of processing is large, selection of continuous and recycling continuous systems are desirable; when the amount of processing is small (up to approximately 1 ton/hr), and when a high demineralization rate is required, batch systems are selected.

## Development into Various Processes

Table 1 gives representative examples of the examination and application of membrane processing in various processes. We will introduce examples of separation applications using filter membranes, applications in purification (demineralization) using filter membranes and electrodialysis and concentration applications using filter membranes.

**Table 1** A summary of processes based on membrane technology and some examples of their application

Application	Type of membrane <sup>*)</sup>	Detail of separation process
Purification	ED	Separation of alcohol and sodium formate
	ED, UF	Desalination of pigment
	ED	Organic acid purification from drainage
Fractionation	UF	Separation of polymer and monomer
	UF	Separation of polymer and organic acid
	UF	Organic recovery from emulsion
Concentration	RO	Concentration of COD component from drainage

<sup>\*)</sup> RO : reverse osmosis membrane, UF : ultrafilter membrane, ED : electrodialysis membrane

## 1. Separation Using Filter Membrane (UF membrane)

### (1) Purification of Resorcin (1,3-Benzenediol) / Lower Order Aldehyde Novolac Resin

Resins that are obtained by condensation polymerization of lower order aldehydes such as resorcin and

formaldehyde are widely used in adhesives and adhesion promoters.

Resins that are obtained by condensation polymerization of resorcin and formaldehyde are improved in adhesion with rubber compositions and fibers through being kneaded into rubber. However, if there is a large amount of unreacted resorcin present in the resin, there are problems such as the occurrence of blooms. There is the method of extracting the resorcin by adding organic solvents as a method for removing the resorcin, but the authors have developed a process for separating the unreacted resorcin and the resin using a filter membrane.<sup>5)</sup>

### (2) Separation Using Filter Membrane

The average molecular weight of resins that have undergone condensation polymerization based on resorcin and lower order aldehydes is approximately 300 - 1,000.

In addition, since the molecular weight of resorcin is 110, an ultra filter membrane made of aromatic polyamide that has a fractionation molecular weight for separating the two of approximately 100 - 300 was selected from the separation performance map. For the separation method, a diafiltration system that continuously adds water to maintain a fixed concentration of the RF resin was used while carrying out membrane

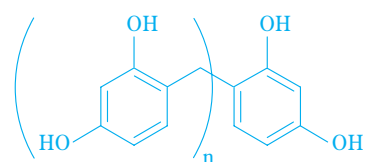

**Fig. 8** Structural formula of RF-resin

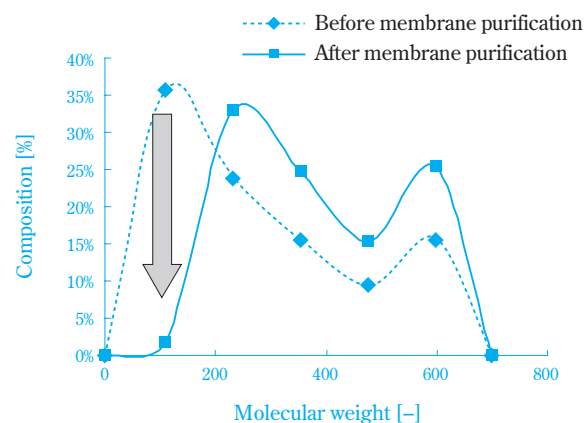

**Fig. 9** Change of distribution of molecular weight

separation of the resorcin/lower order aldehyde resin water solution (RF resin, see Fig. 8). By this means, the unreacted resorcin is in the fluid that passes through, and the resin is held in the concentrated fluid. Fig. 9 shows the distribution of molecular weight in the polymerization mass before and after membrane separation. The proportion in the neighborhood of a molecular weight of 100 in the resin after membrane separation drops, and a resorcin/lower aldehyde resin with a reduced resorcin content is obtained.

## 2. Concentration and Separation Using Filter Membrane (Waste Water Treatment Using Reverse Osmosis Membrane)

### (1) Overview

The process waste water at a Sumitomo Chemical bulk plant has a high level of COD components and BT loaded components (biotreatment), and there was a need to lighten the wastewater burden. Therefore, the authors carried out an examination for finding the reductions in the wastewater burden by eliminating the COD components and BT loaded components in the wastewater and membrane processing.

### (2) Hypothetical Process

The wastewater from the processes in question is produced at 16.4 tons/hr. As a wastewater burden reduction process using membrane processing, the authors proposed a process with membrane concentration of the COD components in this wastewater, furnace incineration of the concentrated fluid and BT processing of the fluid passing through (Fig. 10).

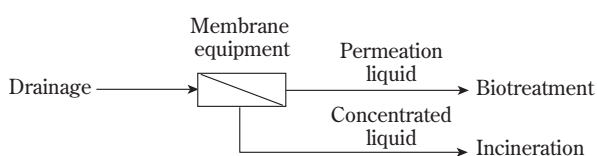

**Fig. 10** Membrane process of drainage

### (3) Details of Examination

To establish the process, we needed to confirm that we had good rejection of the COD components in the wastewater and a 15x concentration (rate of concentration = supply fluid volume / concentrated fluid volume) of the 16.4 tons/hr of wastewater, which is the incineration capacity of the furnace, to 1.1 tons/hr, as well as the fouling effects and the ability to carry out long-term

continuous operation.

#### 1) Membrane Selection

When we examined the COD components in the wastewater, the molecular weight of the substances was approximately 40 - 200. We selected four types from RO membranes - NF membranes as candidates for membranes with which elimination of these was highly possible and carried out dead end filtering tests (filter pressure of 2.5 MPa). The results are given in Table 2.

**Table 2** Result of Dead-end filtration experiment

Name of membrane	Type of membrane	Permeation flux [kg/(m <sup>2</sup> · hr)]	Rejection of COD component [%]	Highly loaded components of Biotreatment
BW-30	RO	23.9	97.5	Blocked
XLE	RO	84.3	97.0	Permeates
NF-90	NF	84.0	79.1	Permeates
DK	NF	154.4	46.0	Permeates

As a result of the tests, BW-30 (Film Tech, Dow Chemical Corp.), which is one type of RO membrane, had the effect of rejecting the COD components and the BT loaded components that are difficult to break down, and we selected this membrane. In addition, not only did BW-30 achieve the target of 15x concentration, but also we selected SW-30 (Film Tech, Dow Chemical Corp.), which is a high pressure type having the same rejection rate as BW-30, for cases when a higher condensation than BW-30 was necessary.

#### 2) Acquisition of Engineering Data

##### (i) Confirmation of Target Concentration Factor

Cross flow filtering tests using a spiral element with BW-30 and SW-30 were carried out, and along with acquiring the engineering data required for the design, we determined whether application in membrane processing was possible or not.

Fig. 11 shows the relationship between the concentration factor and permeation flux during the cross flow filtering tests using BW-30 and SW-30.

From these results, it was possible to assure that the permeation flux during 15 condensation was 10kg/(m<sup>2</sup> · hr), and since a permeation flux effect for the design was obtained, it was confirmed that the target concentration factor could be achieved using two-stage condensation with BW-30 and SW-30.

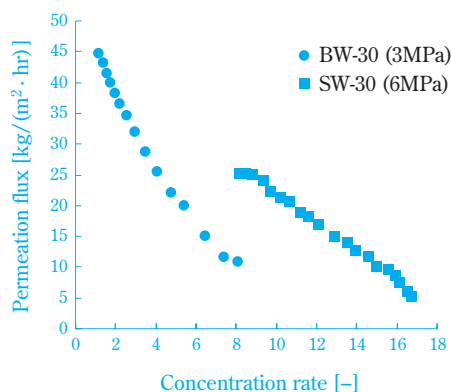

**Fig. 11** Relationship between concentration rate and permeation

(ii) Fouling Effects

Next, we carried out continuous operation for 20 days using BW-30, and checked for changes in the permeation flux and rejection ratio over time due to fouling (Fig. 12). While as a result, somewhat of a drop was seen initially in the permeation flux, it was stable afterwards, and the rejection rate for the COD components was constantly maintained at 90% or greater, so we confirmed that long-term continuous operation of the membrane was possible.

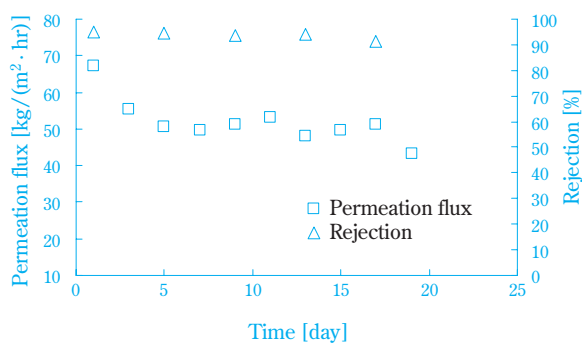

**Fig. 12** Result of tests under continuous operation

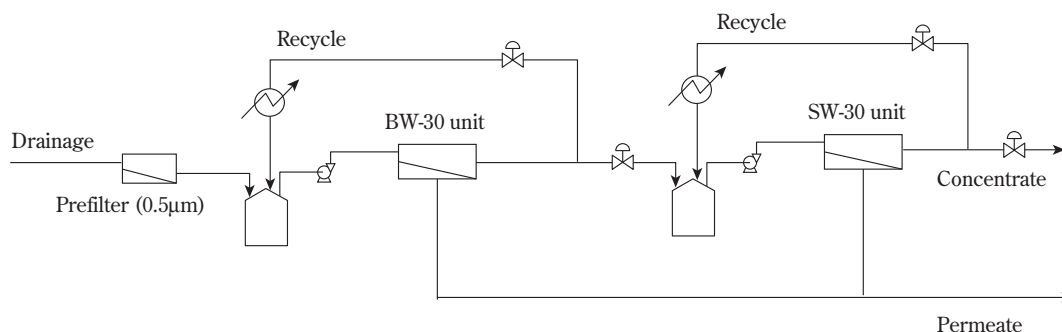

**Fig. 13** Flow diagram of a membrane process

3) Design of Facilities for Membrane Process

Based on the engineering data, was carried out the basic design for the membrane processing.

(i) Design of Condensation System, Membrane Surface Area and Membrane Arrangement

We calculated the required membrane surface areas and membrane arrangements (Christmas tree arrangement) for the condensation system as a continuous condensation system, recycling continuous condensation system and batch condensation system.

As a result, we used a recycling continuous concentration system that minimized the cost of the facility (Fig. 13 and Table 3).

**Table 3** Details of the membrane process

	BW unit	SW unit
Element	BW30-365 (8inch)	SW30HR-380 (8inch)
Membrane area [m <sup>2</sup> ]	813.6	423.6
Arrangement	4inline×3parallel+4inline×2parallel+4inline	4inline×2parallel+4inline
Pumping ability		
Pump head [MPa-A]	5.2	8.5
Feed rate [Ton/hr]	24	12
Concentration rate [-]		
	5.5	2.7
Feed rate		
Provision [Ton/hr]	19.4	9
Concentrate [Ton/hr]	9	7.1
Recycle [Ton/hr]	6	6
Permeate [Ton/hr]	10.4	1.9

3. High-level Purification Using Dyed Desalination

(1) Overview

It was necessary to develop a process to separate the various ions given in Table 4 to their target values in the purification process for phthalocyanine based dyes

**Table 4** Ion content of the process liquid and the required specification

Ion	Content [ppm]	
	Process liquid	Required specification
Cu <sup>2+</sup>	22	15
Li <sup>+</sup>	3410	2500
NH <sub>4</sub> <sup>+</sup>	13	600
Na <sup>+</sup>	8	100
SO <sub>4</sub> <sup>2-</sup>	11100	100
Cl <sup>-</sup>	264	100

(molecular weight of approximately 1400). The fluid being processed is an aqueous solution at 10% by weight, and in particular, the main point is desalinization of the approximately 1 % SO<sub>4</sub><sup>2-</sup> to 100 ppm. Therefore, we will describe of the desalinization investigation we carried out using a filter membrane (diafiltration system) and electro dialysis.

## (2) Desalination Investigation Using Filter Membrane

### 1) Membrane Selection

First of all, we carried out a dead end filtering test to determine whether desalination was possible using a filter membrane. From the separation performance map, we selected several types of nano filters and ultra filters as candidates and conducted filtering tests. As a result, G-10 (Desal Corp., material: cross-linked total aromatic polyamide), which is an ultra filter had a SO<sub>4</sub><sup>2-</sup> rejection rate of 40%, and the permeation flux was 50kg/(m<sup>2</sup> · hr), and it was selected.

### 2) Investigation of Possibilities for Desalination

To carry out desalination to the target value using the selected membrane, we carried out desalination using a diafiltration system that made use of a cross flow filter.

A solvent (ion exchanged water in this system) for the penetrating fluid component eliminated to the outside was added so that the amount of fluid being processed in the filter was constant. The transmittance is defined in (Eq. 3).

Here,  $S$  is the transmittance,  $W_d$  the amount of solvent added and  $W_o$  the amount of fluid being processed.

$$S = \frac{W_d}{W_o} \quad (\text{Eq. 3})$$

Fig. 14 shows the desalination activity with a 10% by weight aqueous solution of the dye.

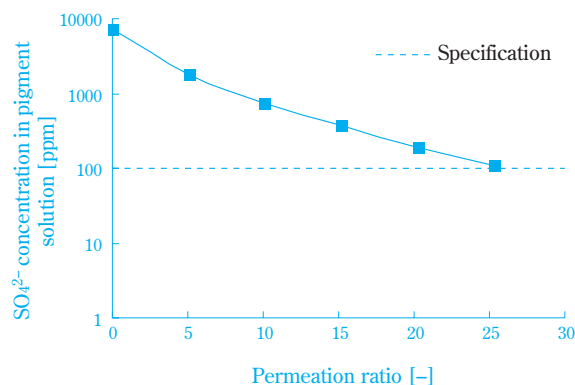
**Fig. 14** Desalination performance of cross-flow filtration

Desalination to the target value was achieved with a transmittance of 25x, and an effective permeation flux of 25kg/(m<sup>2</sup> · hr) was obtained, so desalination using membrane filtration was possible.

## (3) Examination using Electro dialysis

### 1) Membrane Selection

The main points in selection of the membrane are the sufficiency of the permeation flux for Li<sup>+</sup>, which are the main cations that are being eliminated and SO<sub>4</sub><sup>2-</sup>, which are the negative ions, and the minimization of dye loss. For the cation exchange membrane, K192 (ASTOM Corp.) and for the anion exchange membrane, A201 (ASTOM Corp.) were selected from the separation performance map.

### 2) Investigation of Possibilities for Desalination

The data for the various measurements (current value, process fluid/penetrating fluid conductivity, penetrating fluid pH) when the electro dialysis membranes

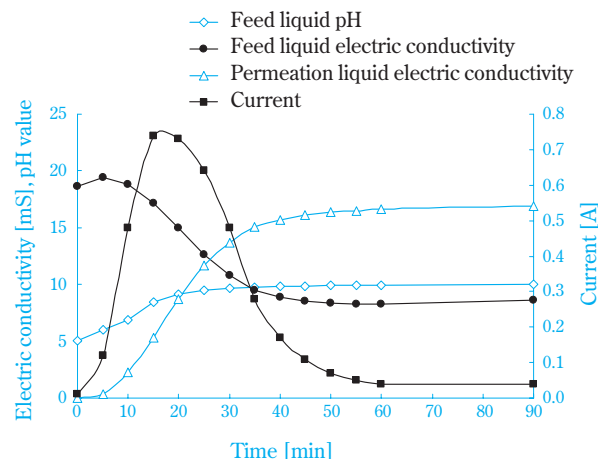
**Fig. 15** Desalination behavior of electro dialysis



described above were used are shown in Fig. 15, and the test conditions are given in Table 5. As the desalination progresses as shown in Fig. 15, the conductivity of the fluid being processed decreases, and the conductivity of the penetrating fluid increases (showing that salt moves from the fluid being processed to the penetrating fluid). In addition, as the desalination progresses, a drop in the current value could be seen (showing that the salt that is passing through is decreasing). Moreover, after a dialysis period of 45 min, the  $\text{SO}_4^{2-}$  concentration in the fluid being processed had gone from 100 ppm to 10ppm, and since it reached the target value, desalination using electro-dialysis is possible.

**Table 5** Comparison of filtration membranes and electro-dialysis membranes

	Filtration membrane	Electro-dialysis membrane
Desalination ability ( $\text{SO}_4^{2-}$ ) [ppm]	100	10
Required necessary membrane area [ $\text{m}^2$ ]	840	50
Capital-investment [M¥]	70	50

### 3) Comparison of Filter Membrane and Electro-dialysis

We have described examples of examination s of desalination and purification using an ultra filter membrane and electro-dialysis. If the desalination specifications are around 100ppm as in this examination, it is possible to use filter membrane separation, but for anything below that, the required transmittance becomes extremely large, and use is difficult. On the other hand, with electro-dialysis, desalination on the order of several tens of ppm is possible, and compared with filter membranes, the membrane surface area required is small and the equipment is compact (Table 5), so it is an extremely promising process for items with strict specifications.

## New Technology

### 1. Development of Membrane Emulsification

Up to now we have described membranes that are used in separation techniques. However, by using the properties of membranes, it is possible for them to be used in processes other than separation techniques. We will introduce membrane emulsification as one of these.

#### (1) Membrane Emulsification<sup>6)</sup>

The principle of membrane emulsification is that the dispersed phase liquid (water phase, oil phase) passes through the small holes in a porous membrane, are dispersed in the continuous phase as very fine droplets and an emulsion is obtained (Fig. 16). Compared with the conventional mechanical processing methods (agitating emulsifiers, high pressure homogenizers and the like), there are the merits of its being possible to produce a stable emulsion with a monodispersion because the uniformity of the small holes in the membrane is used and having a low emulsion energy. The authors are currently investigating applications in crystallization technology and the like, focusing on the point that the droplets for the fine monodispersion can be adjusted in membrane emulsification.

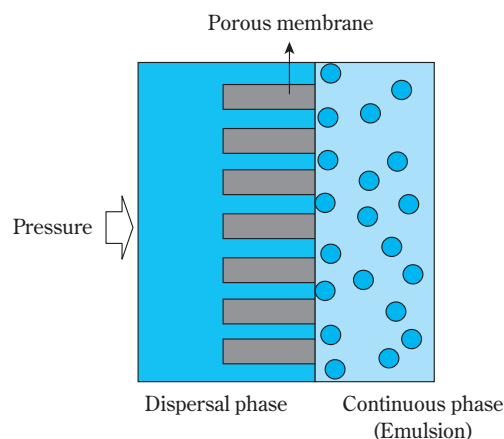

**Fig. 16** Principle of membrane emulsification

## 2. Techniques for Induction of Characteristic Ions

We have discussed the separation of ion types like that in desalination using electro-dialysis up to this point. However, electro-dialysis can be used for ion exchange methods other than separation.

The authors have found a methods for producing valuable materials using effective ion exchange methods that make use of the various ion exchange membrane capabilities.

We will describe the production of fluorinated organic quaternary ammonium as an example.<sup>7)</sup>

#### (1) Fluorinated Organic Quaternary Ammonium

Fluorinated organic quaternary ammonium like fluorinated tetra-n-butyl ammonium (Fig. 17) and the like are extremely useful compounds as detaching agents for silyl groups, which are protective groups, inter-

phase transition catalysts, and trial reactions for organic reactions of fluorination agents and the like.

The method of reacting a salt of organic ammonium with a fluorinated metal salt such as potassium fluoride is often used as a production method for fluorinated organic quaternary ammonium, but there are problems in that they include large amounts of salts such as other halogen salts and sulfates. The authors have developed a process for producing fluorinated organic quaternary ammonium by carrying out ion exchange with a salt of organic ammonium and a fluorinated metal salt by means of ion exchange using electro dialysis.

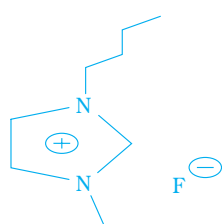
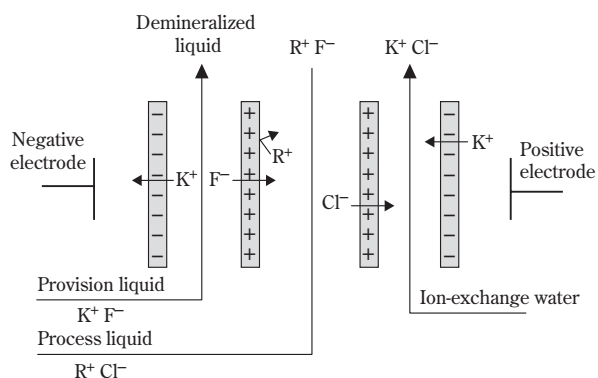

**Fig. 17** Structural formula of tetra-n-butylammonium

## (2) Ion Exchange Using Electrodialysis

As is shown in **Fig. 18**, cation exchange membranes and anion exchange membranes are positioned and three chambers, a supply chamber, a processing chamber and a waste liquid chamber are created.

An aqueous fluorinated metal salt solution flows in the supply chamber, aqueous organic ammonium salt solution in the processing chamber and water in the waste liquid chamber, and if a voltage is applied to both ends, the fluorine ions in the supply chamber move to



**Fig. 18** Ion exchange dialysis

the processing chamber and at the same time, the anions in the processing chamber move to the waste liquid chamber, so anion exchange is carried out in the processing chamber, and fluorinated tetra-n-butyl ammonium is obtained. The yield was approximately 80%.

## Summary

As has been discussed in this paper, high level separation processes can be constructed with filter membranes and electro dialysis by selecting suitable membranes and selecting processing methods. In addition, by making use of the properties of membranes, it is possible to use them in applications other than separation. In recent years, membranes with chemical resistance, heat resistance, and high durability and membranes that are given functions such as stimulated (temperature and pH) reactivity, optical functionality and the like have been developed, and their range of application is broadening. We will be grateful if this paper helps in the development of membrane technology processes using the properties of membranes.

## References

- 1) Kanji Matsumoto, "Membrane separation technology for user", First edition, The Nikkan Kogyo Shim bun, Ltd. (1996), p.5.
- 2) Shigeki Sawada, "Available membrane filtration technology in the field", First edition, Kogyo Chosakai Publishing, Inc (2006), p.14.
- 3) Manabu Senoo, Akihiko Tanioka, Shigeru Itoi, Akira Yamauchi, Syouichiro Yoshida, "Function and application of ion-exchange membranes". First edition, Industrial Publishing&Consulting, Inc (2004), p.61.
- 4) Haruhiko Oya, Atsuo Watanabe, "Food membrane technology" First edition, Korin Publishing Co. Ltd. (1999), p.206.
- 5) Sumitomo Chemical Co., Ltd., JP2002-327034 (2002).
- 6) Haruhiko Oya, Atsuo Watanabe, "Food membrane technology" First edition, Korin Publishing Co. Ltd. (1999), p.503.
- 7) Sumitomo Chemical Co., Ltd., JP2006-306753 (2006).

PROFILE



*Masahiko KURUMATANI*

Sumitomo Chemical Co., Ltd.  
Process and Production Technology Center  
Senior Research Associate



*Takenori KITAURA*

Sumitomo Chemical Co., Ltd.  
Process and Production Technology Center  
Researcher